

# 赤外線センサ

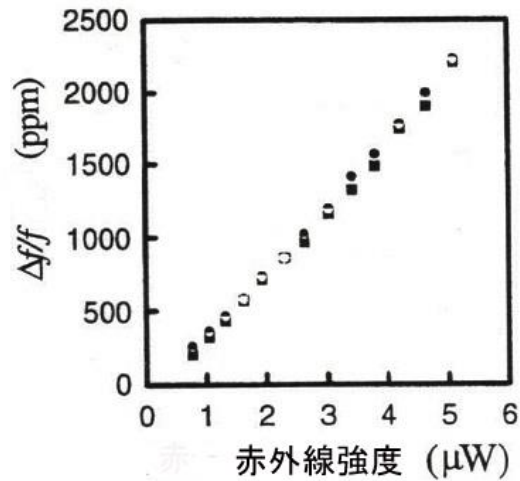

振動型赤外線センサ

参考文献 : C.Cabuz, S.Shoji, K.Fukatsu, E.Cabuz, K.Minami and M.Esashi, Fabrication and Packaging of a Resonant Infrared Sensor Integrated in Silicon, Sensors and Actuators A, 43 (1994) pp.92-99

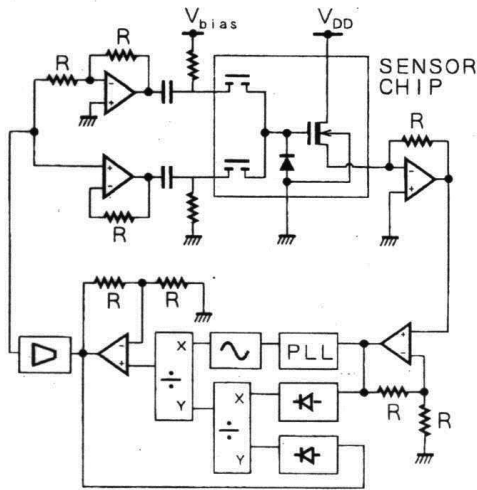
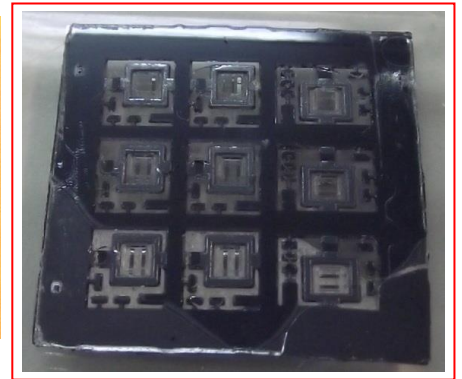
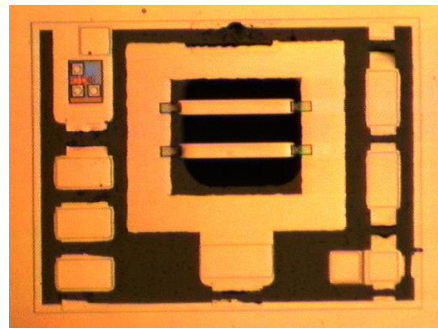
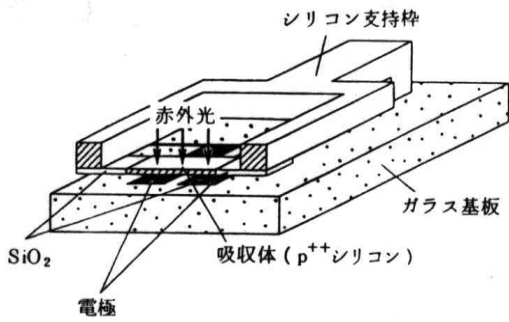
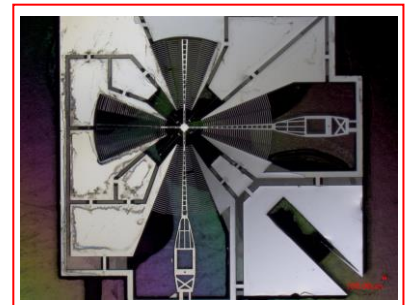
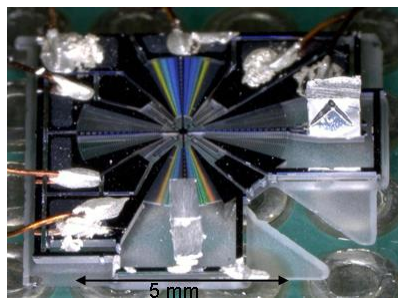
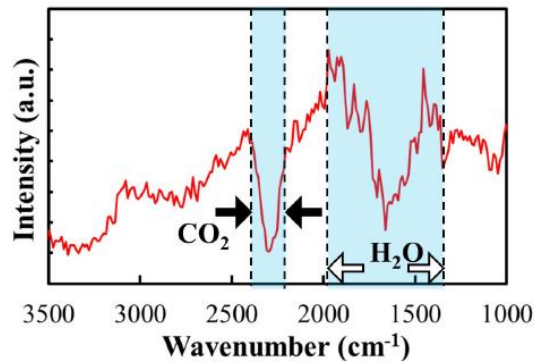
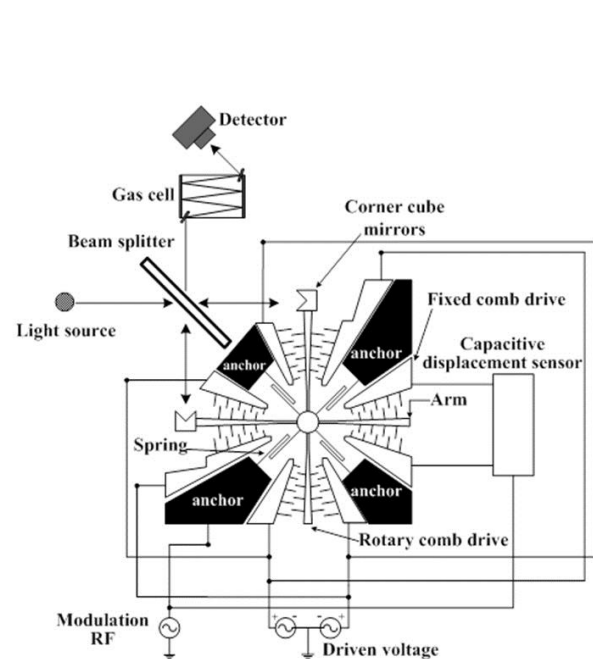

マイクロ化フーリエ変換型赤外分光計

参考文献 : Y.-M. Lee, M. Toda, M. Esashi, and T. Ono, Micro wishbone interferometer for Fourier transform infrared spectrometry, J. of Micromechanics and Microengineering, 21 (2011) 065039